

A5500/A5600 SERIES Ø1.58 Plug Wire to Wire Connector

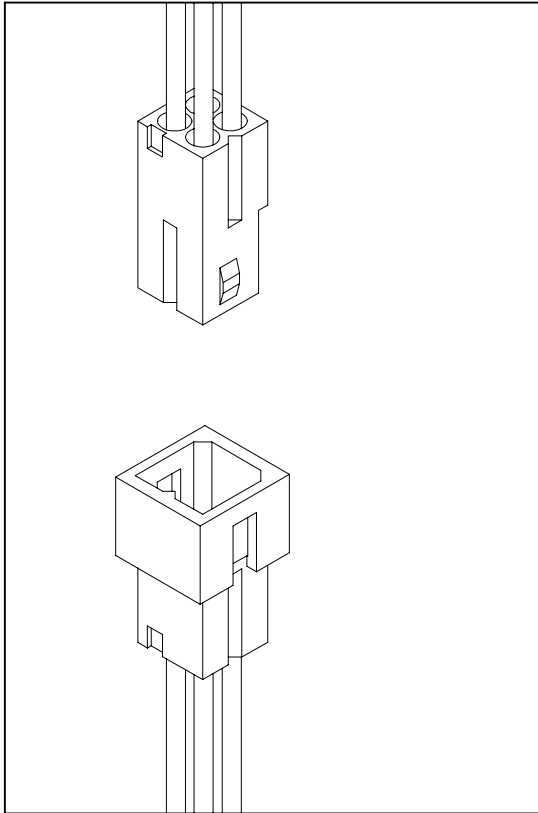

Assembly Layout/装配方案

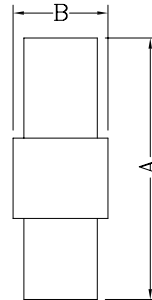

Poles 位数	Dimensions/尺寸	
	A	B
1X1	30.5	7.5
1X2	32.2	7.5
1X3	31.0	7.5
1X4	31.0	7.5
1X5	31.2	7.5
2X2	30.3	11.2
2X3	31.0	15.0
3X3	32.0	15.0
3X4	32.0	15.0
3X5	31.6	15.0

Specifications/技术参数:

Poles/位数	1~15 Poles
Plug Diameter/插头直径	Ø1.58mm
Rated Voltage/额定电压	250V AC,DC
Rated Current/额定电流	5A (AWG #20)
Withstand Voltage/耐压值	1500V AC/minute
Contact Resistance/接触电阻	10mΩ (MAX.)
Insulation Resistance/绝缘电阻	1000MΩ (MIN.)
Temperature Range/温度范围	-25°C ~ +85°C
Applicable Wire Range/适用线径	AWG #20~#24

A5500 SERIES Ø1.58 Plug Crimp Terminal

Features/产品特性:

* Used in A5500 series socket (用于A5500系列塑壳)

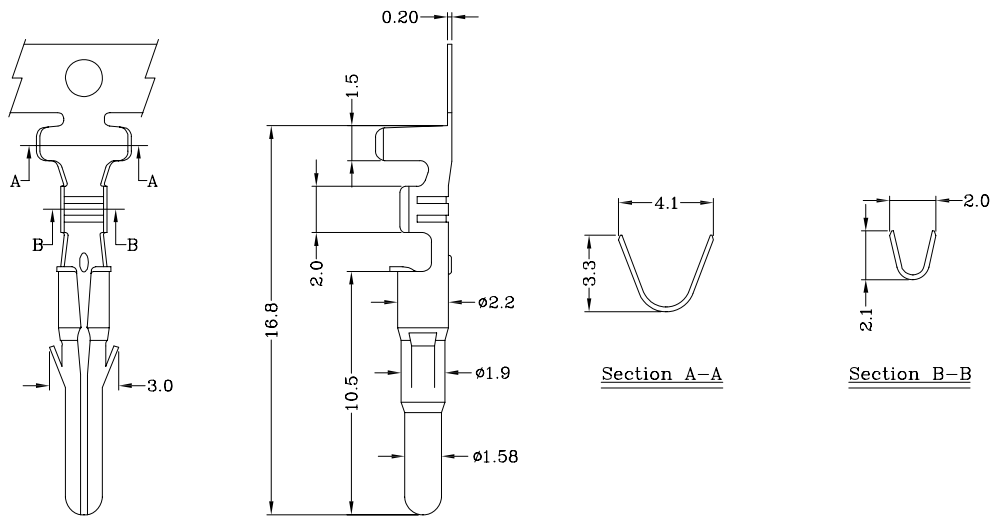

Part No./产品型号	Wire Range/线径范围	Insulation O.D/线外径	Material/材质	Finish/表面处理
A5500T	AWG #20 ~ #24	3.00mm(max)	Brass	Tin-plated

A5600 SERIES Ø1.58 Receptacle Crimp Terminal

Features/产品特性:

* Used in A5600 series socket (用于A5600系列塑壳)

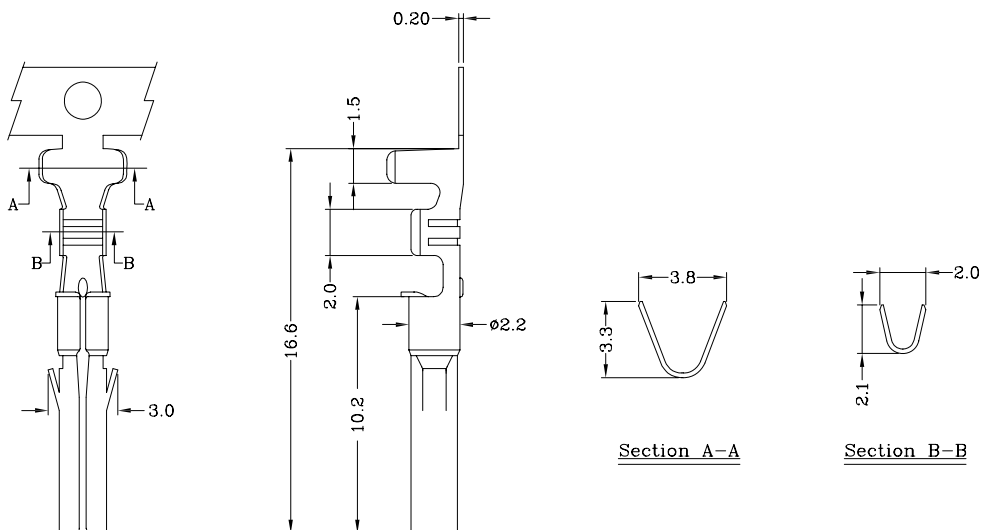

Part No./产品型号	Wire Range/线径范围	Insulation O.D/线外径	Material/材质	Finish/表面处理
A5600T	AWG #20 ~ #24	3.00mm(max)	Brass	Tin-plated

A5500/A5600 SERIES Ø1.58mm Plug and Receptacle Terminal Socket

Features/产品特性:

- * Single, Dual & Triple Row Terminal Socket(单排,双排和三排端子塑壳)
- * Material(材质): Nylon 66 UL 94V-2 (Natural)

Specification /产品说明:

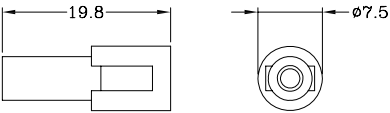
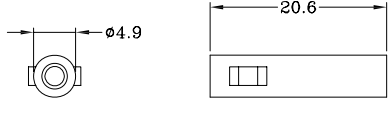
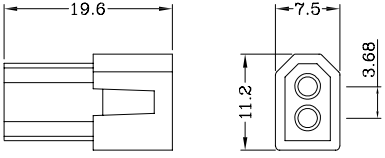
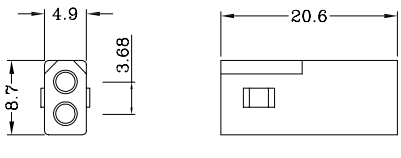
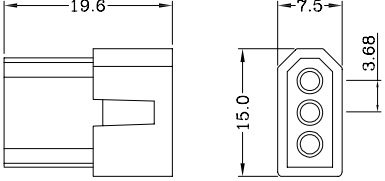
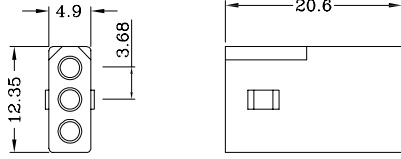
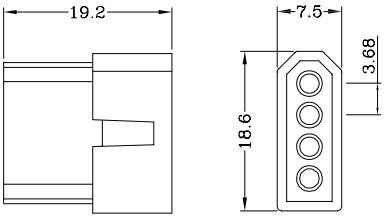
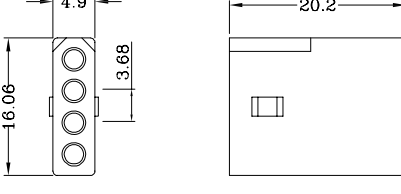
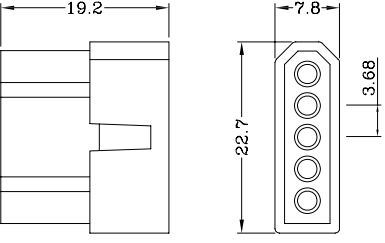
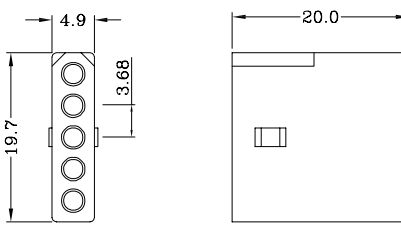
PLUG/插头	RECEPTACLE/插座
 <p style="text-align: center;"><u>A5500H-1*01P</u></p>	 <p style="text-align: center;"><u>A5600H-1*01P</u></p>
 <p style="text-align: center;"><u>A5500H-1*02P</u></p>	 <p style="text-align: center;"><u>A5600H-1*02P</u></p>
 <p style="text-align: center;"><u>A5500H-1*03P</u></p>	 <p style="text-align: center;"><u>A5600H-1*03P</u></p>
 <p style="text-align: center;"><u>A5500H-1*04P</u></p>	 <p style="text-align: center;"><u>A5600H-1*04P</u></p>
 <p style="text-align: center;"><u>A5500H-1*05P</u></p>	 <p style="text-align: center;"><u>A5600H-1*05P</u></p>

A5500/A5600 SERIES $\varnothing 1.58\text{mm}$ Plug and Receptacle Terminal Socket

Specification/产品说明：

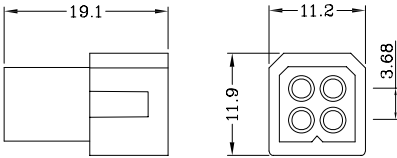
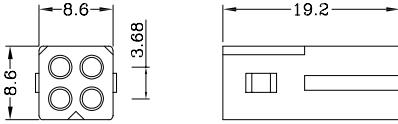
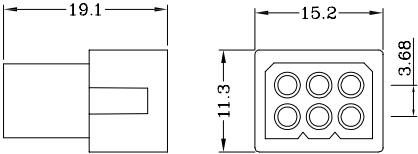
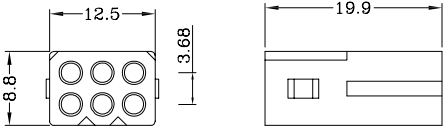
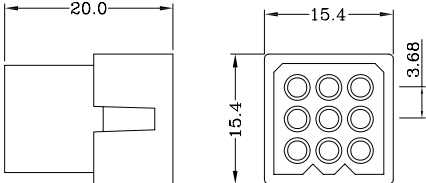
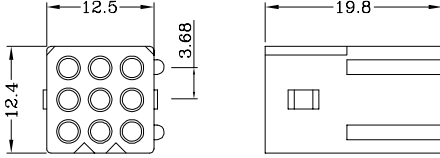
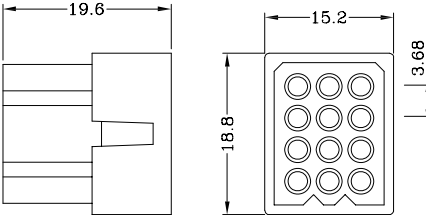
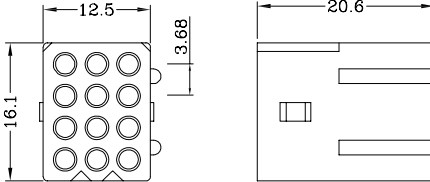
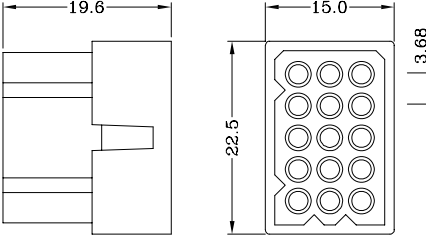
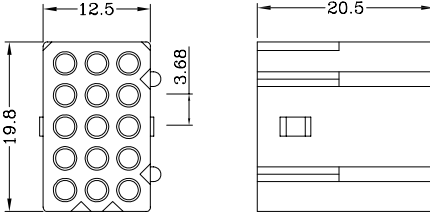
PLUG/插头	RECEPTACLE/插座
 <p style="text-align: center;"><u>A5500H-2*02P</u></p>	 <p style="text-align: center;"><u>A5600H-2*02P</u></p>
 <p style="text-align: center;"><u>A5500H-2*03P</u></p>	 <p style="text-align: center;"><u>A5600H-2*03P</u></p>
 <p style="text-align: center;"><u>A5500H-3*03P</u></p>	 <p style="text-align: center;"><u>A5600H-3*03P</u></p>
 <p style="text-align: center;"><u>A5500H-3*04P</u></p>	 <p style="text-align: center;"><u>A5600H-3*04P</u></p>
 <p style="text-align: center;"><u>A5500H-3*05P</u></p>	 <p style="text-align: center;"><u>A5600H-3*05P</u></p>